



Emerson[®]

***HOME AUDIO SYSTEM
with 6 CD CHANGER
and CASSETTE RECORDER***



OWNER'S MANUAL

MS9700

Visit our web site at www.emersonradio.com





CAUTION

TO PREVENT FIRE OR SHOCK HAZARD, DO NOT USE THIS PLUG WITH AN EXTENSION CORD, RECEPTACLE OR OTHER OUTLET UNLESS THE BLADES CAN BE FULLY INSERTED TO PREVENT BLADE EXPOSURE. TO PREVENT FIRE OR SHOCK HAZARD, DO NOT EXPOSE THIS APPLIANCE TO RAIN OR MOISTURE.



The lightning flash with arrow-head symbol, within an equilateral triangle is intended to alert the user to the presence of uninsulated 'dangerous voltage' within the product's enclosure that may be of sufficient magnitude to constitute a risk of electric shock to persons.

CAUTION

RISK OF ELECTRIC SHOCK
DO NOT OPEN

WARNING: TO REDUCE THE RISK OF ELECTRIC SHOCK DO NOT REMOVE COVER (OR BACK), NO USER SERVICEABLE PARTS INSIDE REFER SERVICING TO QUALIFIED SERVICE PERSONNEL.



The exclamation point within an equilateral triangle is intended to alert the user to the presence of important operating and maintenance (servicing) instructions in the literature accompanying the appliance.

IMPORTANT SAFETY INSTRUCTIONS

- 1.) Read these instructions.
- 2.) Keep these instructions.
- 3.) Heed all warnings.
- 4.) Follow all instructions.
- 5.) Do not use this apparatus near water.
- 6.) Clean only with dry cloth.
- 7.) Do not block any ventilation openings. Install in accordance with the manufacturer's instructions.
- 8.) Do not install near any heat sources such as radiators, heat registers, stoves, or other apparatus (including amplifiers) that produce heat.
- 9.) Do not defeat the safety purpose of the polarized or grounding-type plug. A polarized plug has two blades with one wider than the other. A grounding type plug has two blades and a third grounding prong. The wide blade or the third prong are provided for your safety. If the provided plug does not fit into your outlet, consult an electrician for replacement of the obsolete outlet.
- 10.) Protect the power cord from being walked on or pinched particularly at plugs, convenience receptacles, and the point where they exit from the apparatus.
- 11.) Only use attachments / accessories specified by the manufacturer.
- 12.) Unplug this apparatus during lightning storms or when unused for long periods of time.
- 13.) Refer all servicing to qualified service personnel. Servicing is required when the apparatus has been damaged in any way, such as power-supply cord or plug is damaged, liquid has been spilled or objects have fallen into the apparatus, the apparatus has been exposed to rain or moisture, does not operate normally, or has been dropped.
- 14.) This appliance shall not be exposed to dripping or splashing water and no object filled with liquids such as vases shall be placed on the apparatus.
- 15.) Do not overload wall outlet. Use only power source as indicated.
- 16.) Use replacement parts as specified by the manufacturer.
- 17.) The product may be mounted to a wall only if recommended by the manufacturer.
- 18.) Upon completion of any service or repairs to this product, ask the service technician to perform safety checks.



BEFORE WE BEGIN

Thank you for purchasing this Emerson product. The Emerson brand is your assurance of quality, performance and value.

Our engineers have included many useful and convenient features in this product. Please be sure to read this Owner's Manual completely to make sure you are getting the maximum benefit from each feature.

This product was manufactured using the highest quality components and standards of workmanship. It was tested by Emerson inspectors and found to be in perfect working order before it left our factory. However, there is always the chance that some problem may occur because of rough handling during shipment to the retail store or to the final consumer.

If, after reading this Manual, you experience any problems with the operation of this product, please refer to the instructions for obtaining service at the end of this Manual. Emerson and Emerson retailers are committed to your satisfaction. Once again, thanks for purchasing this Emerson audio product.

For future reference, record the serial number in the space below.

Model: MS9700

Serial Number : _____



IMPORTANT NOTES

Avoid installing the unit in locations described below :

- Places exposed to direct sunlight or close to heat radiating appliances such as electric heaters, on top of other stereo equipment that radiates too much heat, places lacking ventilation or dusty areas, places subject to constant vibration and/or humid or moist areas.
- Do not attempt to clean this unit with chemical solvents as this might damage the finish. Use a clean dry cloth.
- Operate controls and switches as described in the manual.
- Before turning 'On' the power, make certain that the speakers are properly installed.
- Store your cassette tapes and CDs in a cool area to avoid damage from heat.
- When moving the set, be sure to first disconnect the power cord and remove cords connected to other equipment.

CLASS 1 LASER PRODUCT

CLASS 1 LASER PRODUCT
APPAREIL À LASER DE CLASSE 1
PRODUCTO LASER DE CLASE 1

CAUTION
INVISIBLE LASER RADIATION
WHEN OPEN AND INTERLOCKS
DEFEATED.
AVOID EXPOSURE TO BEAM



This product contains a low power Laser Device.

FCC INFORMATION

This equipment has been tested and found to comply with the limits for a Class B digital device, pursuant to Part 15 of the FCC Rules. These limits are designed to provide reasonable protection against harmful interference in a residential installation. This equipment generates, uses, and can radiate radio frequency energy and, if not installed and used in accordance with the instructions, may cause harmful interference to radio communications. However, there is no guarantee that interference will not occur in a particular installation. If this equipment does cause harmful interference to radio or television reception, which can be determined by turning the equipment off and on, the user is encouraged to try to correct the interference by one or more of the following measures:

- Reorient or relocate the receiving antenna.
- Increase the separation between the equipment and receiver.
- Connect the equipment into an outlet on a circuit different from that to which the receiver is connected.
- Consult the dealer or an experienced radio/TV technician for help.

This device complies with Part 15 of the FCC Rules. Operation is subject to the following two conditions:

- (1) This device may not cause harmful interference, and
- (2) This device must accept any interference received, including interference that may cause undesired operation.



PREPARATION FOR USE

UNPACKING

- Remove the main unit and the speakers from the carton and remove all packing materials from the components.
- Remove any descriptive labels from the fronts of the main unit and speakers.
- Remove any small strips of tape that may have been used to secure the cassette door or CD drawer in transit.

PLACEMENT

- Place the unit on a stable, level table, shelf or stand convenient to an AC outlet.
- The unit should not be exposed to direct sunlight or sources of excess heat, moisture, dust, vibration, or humidity.
- The speakers may be positioned along side the main unit, or separated as far as the cords will allow for maximum stereo separation. You should maintain a gap of at least one inch between the main unit and the speakers to prevent any skipping of the CD player when the unit operated at high volume.

PROTECT YOUR FURNITURE !!

This model is equipped with non-skid rubber 'feet' to prevent the product from moving when you operate the controls. These 'feet' are made from non-migrating rubber material specially formulated to avoid leaving any marks or stains on your furniture. However certain types of oil based furniture polishes, wood preservatives, or cleaning sprays may cause the rubber 'feet' to soften, and leave marks or a rubber residue on the furniture. To prevent any damage to your furniture we strongly recommend that you purchase small self-adhesive felt pads, available at hardware stores and home improvement centers everywhere, and apply these pads to the bottom of the rubber 'feet' before you place the product on fine wooden furniture.



SPEAKER CONNECTION

The speaker cables and the speaker terminals on the back of the main unit are color coded for your convenience. Connect the cables from the left speaker to the “LEFT” terminals, and the cables from the right speaker to the “RIGHT” terminals.

To connect the speaker cable to the terminal depress the plastic tab below the terminal, insert the bare wire at the end of the cable into the terminal opening, and release the plastic tab to lock the wire in place.

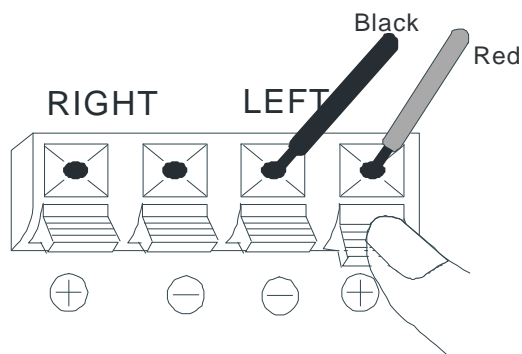

Be sure to connect the Red cables to the Red terminals and the Black cables to the Black terminals. If the speakers are connected incorrectly the sound may be “muddy” and distorted.

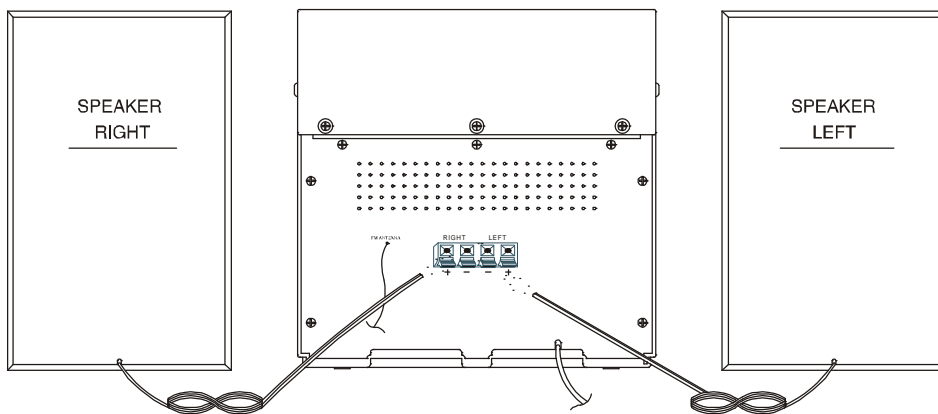



CONNECTING THE AC POWER CORD

After connecting the speakers unwind the AC power cord fully and connect it to any convenient household AC outlet. This system is designed to operate on 120V 60Hz AC power only. Connecting this system to any other power supply may cause damage to the unit which is not covered by your warranty.

This unit has a polarized AC plug with one wide blade and one narrow blade. This plug will only fit into a matching polarized AC outlet. This is a safety feature to reduce the possibility of electric shock. If this plug will not fit in your AC outlet, you probably have an outdated non-polarized outlet. You should have your outdated outlet changed by a qualified, licensed electrician. Do not file the wide blade on the plug, or use an adapter to make the plug fit into your outlet. This defeats the safety feature and could expose you to electric shock.

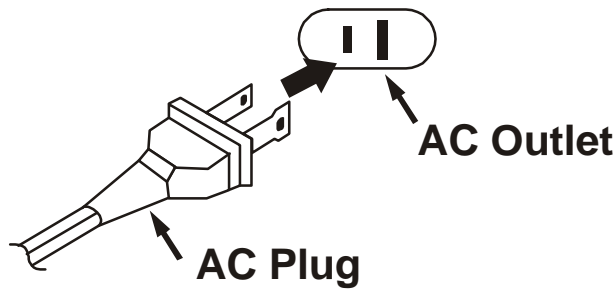



ANTENNA INFORMATION

FM

This unit has an external lead wire FM antenna permanently attached to the back of the main cabinet. Unwrap this antenna wire, extend it to its full length, and allow it to hang down from the back of the set. In some cases you may have to vary the direction of this antenna until you find the position that provides the best reception, and then use a small piece of tape to secure the antenna in that position.

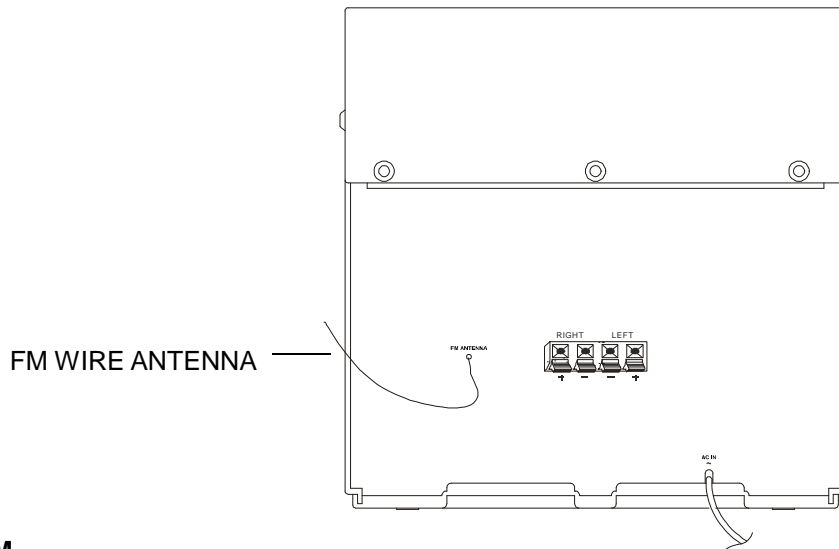

AM

This system has a built in AM ferrite bar antenna. You may have to vary the position and direction of this main unit until you find the position that provides the clearest reception for each of your favorite AM stations.

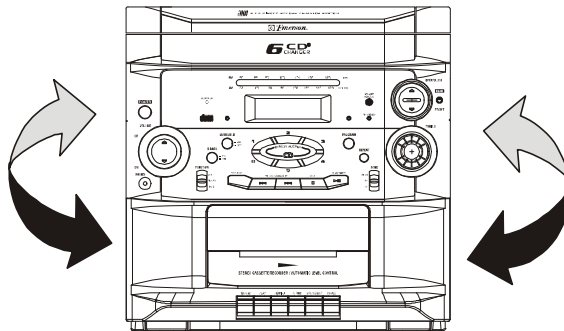

LOCATION OF CONTROLS AND INDICATORS

FRONT PANEL

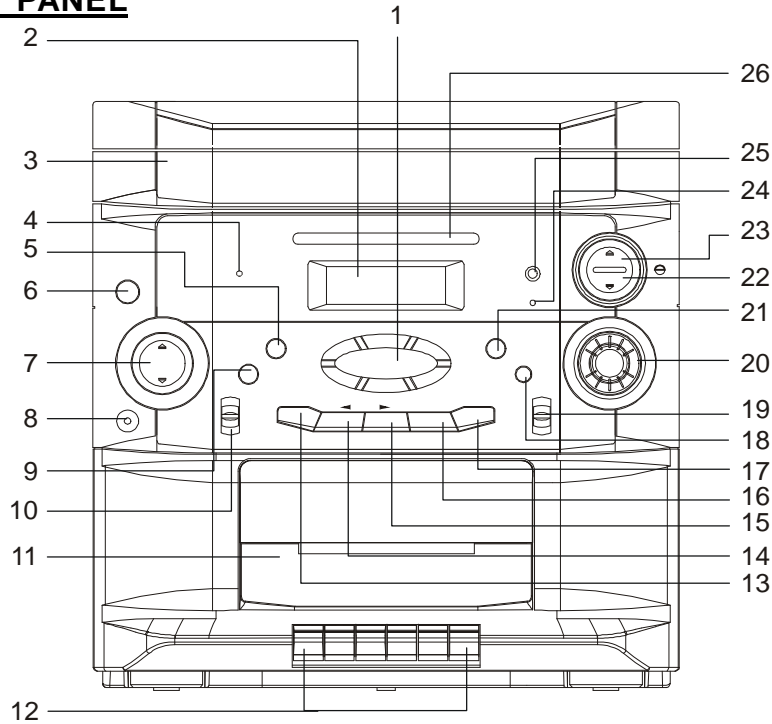

- | | |
|--|--|
| 1.) CD DIRECT ACCESS Buttons. | 13.) DISC SCAN Button. |
| 2.) Multifunction LCD Display. | 14.) CD Reverse SKIP/SEARCH ◀◀ Button. |
| 3.) 6 CD Changer Tray. | 15.) CD Forward SKIP/SEARCH ▶▶ Button. |
| 4.) POWER ON Indicator. | 16.) CD STOP ■ Button. |
| 5.) SURROUND (■ ON / ■ OFF) Button. | 17.) CD PLAY/PAUSE ▶ Button. |
| 6.) POWER (On/Off) Button. | 18.) REPEAT Button. |
| 7.) VOLUME (UP/DN) Buttons. | 19.) BAND (FM ST/FM/AM) Selector. |
| 8.) PHONES Jack. | 20.) TUNING Control. |
| 9.) X-BASS (■ ON / ■ OFF) Button. | 21.) PROGRAM Button. |
| 10.) FUNCTION (CD/TUNER/TAPE) Selector. | 22.) OPEN/CLOSE (FRONT) Button. |
| 11.) Cassette Door. | 23.) OPEN/CLOSE (REAR) Button. |
| 12.) Cassette Deck Control Keys.
(RECORD-PLAY-REWIND-F. FWD
-STOP/EJECT-PAUSE) | 24.) FM STEREO Indicator. |
| | 25.) REMOTE SENSOR. |
| | 26.) Dial Scale & Pointer. |



BACK PANEL

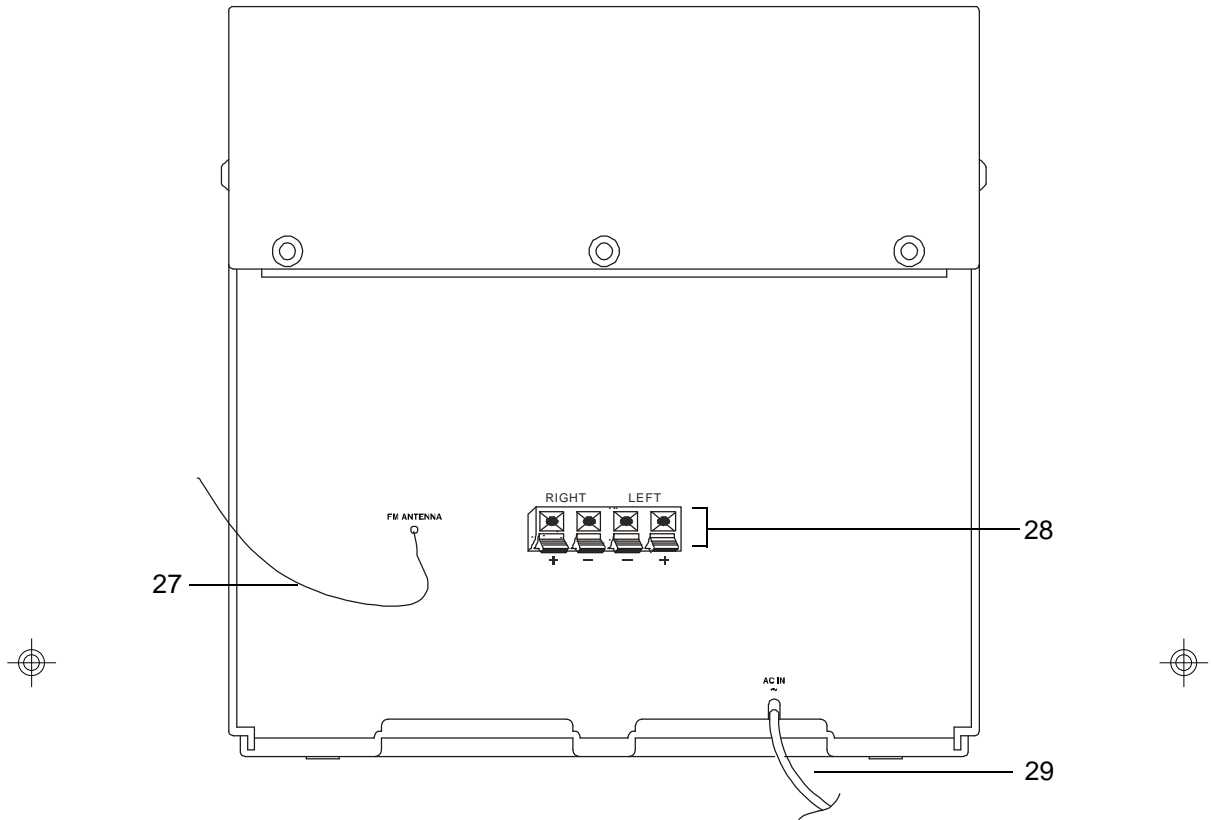



- 27.) FM Wire ANTENNA.
- 28.) Speaker Terminals.
- 29.) AC Power Cord.





MULTIFUNCTION LCD DISPLAY (For CD Operations Only)



 — Disc location indicators

 — Indicates Disc 1 is at back half of tray.

 — Indicates Disc 1 is at front half of tray.

 — Indicates Disc 1 is in play position.

 — Indicates Disc 1 is playing.

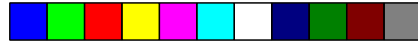

REMOTE CONTROL

- 1.) OPEN/CLOSE (REAR) Button.
- 2.) Disc 2 Button.
- 3.) Disc 1 Button.
- 4.) Disc 6 Button.
- 5.) DISC SCAN Button.
- 6.) PROG (Program) Button.
- 7.) INTRO Button.
- 8.) REPEAT Button.
- 9.) RANDOM Button.
- 10.) CD STOP ■ Button.
- 11.) CD PAUSE || Button.
- 12.) VOLUME DN Button.
- 13.) VOLUME UP Button.
- 14.) CD PLAY ► Button.
- 15.) SKIP Forward ►► Button.
- 16.) SKIP Reverse ◄◄ Button.
- 17.) Disc 5 Button.
- 18.) Disc 4 Button.
- 19.) Disc 3 Button.
- 20.) OPEN/CLOSE (FRONT) Button.
- 21.) POWER On/Off Button.

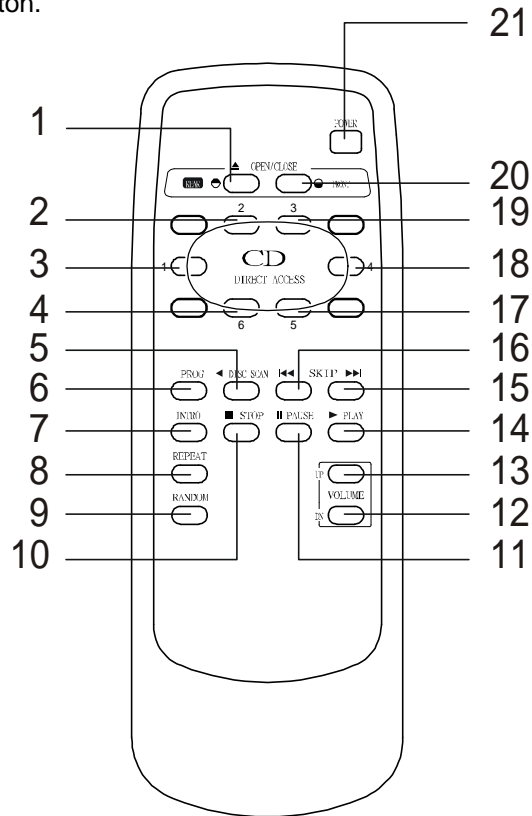



BATTERY INSTALLATION

Insert 2 'AAA' size alkaline batteries, not included, into the battery compartment of the remote handset, observing the battery polarity and replace the cover.

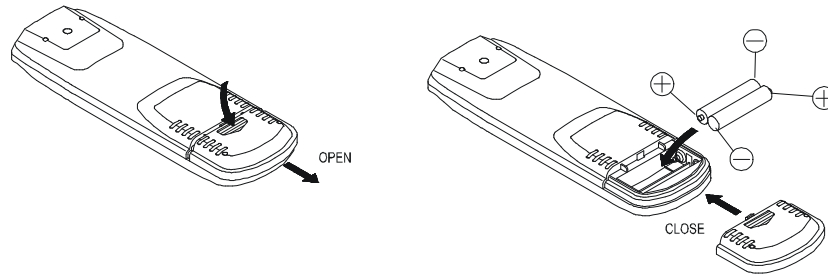

BATTERY REPLACEMENT

When the batteries become too weak, the operating distance of the remote handset is greatly reduced and you will need to replace the batteries.

NOTES:

- To maintain the accuracy and long life of the transmitter, do not press two or more buttons simultaneously.
- If the remote control is not to be used for a long time, remove the batteries to prevent possible damage through leaking batteries.
- Do not mix different types of batteries, or old batteries with new ones.

USING THE REMOTE CONTROLLER CORRECTLY

- Point the remote handset at the Remote Sensor on the front panel.
- The functions of the buttons on the remote handset are the same as the corresponding controls on the main unit.
- When there is a strong ambient light source, the performance of the infrared Remote Sensor may be degraded, causing unreliable operation.
- The maximum effective distance for remote control operation is about 16 feet (Approx. 5m)

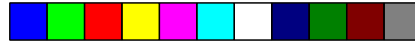



OPERATING INSTRUCTIONS

SOUND CONTROLS



VOLUME

Press the VOLUME UP or DN (Down) buttons on the front panel, or on the remote control to increase or decrease the volume level. The system memory remembers the volume level when the power is shut off and automatically returns to the same level when the power is switched on again.



X-BASS BOOST BUTTON

Press the X-BASS (Bass Boost) button ( ON) on the front panel to enhance the bass response. Press again ( OFF) to cancel X-BASS boost.

Use X-BASS when you are listening at low volume levels where the bass tends to disappear.

- If you are listening to music with heavy bass at high volume and the X-BASS  ON, you may experience some distortion.
- If this occurs, switch the X-BASS  OFF, or reduce the volume level.

SURROUND (STEREO WIDE) BUTTON

Set the SURROUND button to the 'On' position ( ON) for an expanded stereo/surround effect. This causes a very slight delay in the sound coming from one of the speakers and creates a feeling of added width and depth. Set the SURROUND button back to the 'Off' position ( OFF) to restore normal stereo sound.

Note: The SURROUND button only works with stereo sound sources. You will not get any 'Surround Effect' from mono AM radio, or other mono sound sources.



LISTENING TO THE RADIO

- 1.) Press the POWER button to turn the system 'On'. The POWER ON indicator lights.
- 2.) Slide the FUNCTION selector to the 'TUNER' position.
- 3.) Slide the BAND selector to the desired band, FM ST (Stereo), FM, or AM.
- 4.) Rotate the TUNING control to find the desired station.

Note: *If you tune to an FM Stereo station and the BAND selector is set to FM ST, the FM STEREO indicator will light. If the FM reception is noisy or weak you may be able to improve it by sliding the BAND selector to the FM (Mono) position, however the sound will no longer be in stereo.*

- 5.) Adjust the VOLUME and X-BASS controls as desired.
- 6.) When you are finished listening press the POWER button to turn the system 'Off'. The POWER ON indicator goes out.





PLAYING COMPACT DISCS

This system features a unique “double decker” CD changer that holds 3 CDs in the upper tray and 3 CDs in the lower tray. When 6 CDs are loaded in the changer you can enjoy over 6 hours of uninterrupted music (depending on the length of the individual discs).

UNDERSTANDING THE CD DISPLAY

In addition to the normal track number and elapsed time information the CD display in this system includes icons which show you the position of each disc on the platter at any given time, and which of the 6 discs is in the playing position.

Refer to the following illustration.

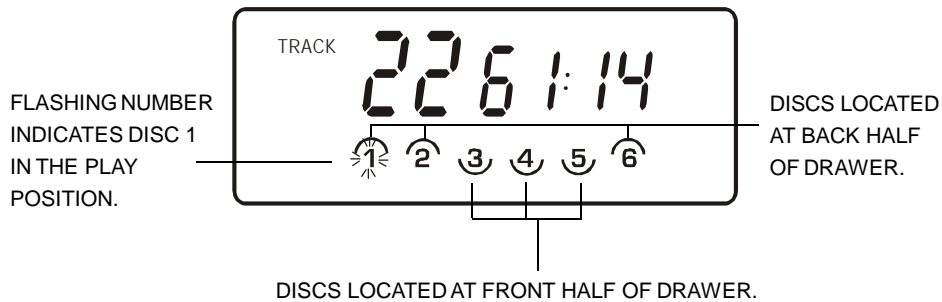

This diagram shows that there are 6 CDs in the changer. The half circles above the disc numbers indicate that Discs 1, 2, and 6 are at the back half of the drawer. The half circles below the disc numbers indicate that Discs 3, 4, and 5 are at the front half of the drawer. The flashing number 1 indicates that Disc 1 is in the play position. The display also indicates that Disc 1 has 22 tracks and a total playing time of 61 minutes and 14 seconds. If the PLAY ► button is pressed in this illustration the number 1 will stop flashing and the half circle above the number will begin to flash indicating that Disc 1 is playing. Refer to the following illustration:

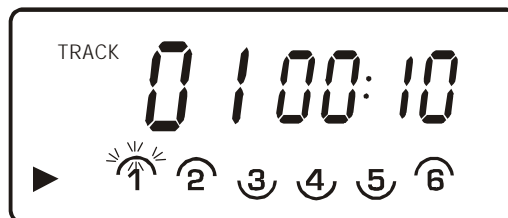



As each disc plays and the drawer rotates the disc location icons will show which discs are at the back of the drawer and which discs are at the front of the drawer.

NORMAL PLAYBACK

- 1.) Press the POWER button to turn the system 'On'. The POWER ON indicator lights. Slide the FUNCTION selector to the 'CD' position. The LCD display lights.
- 2.) Press the lower half (FRONT) of the OPEN/CLOSE button on the front panel, or the FRONT open button on the remote control, to open the CD drawer immediately. As the drawer opens the front edge of the drawer drops down slightly to allow easier access to the lower tray. See following illustration.

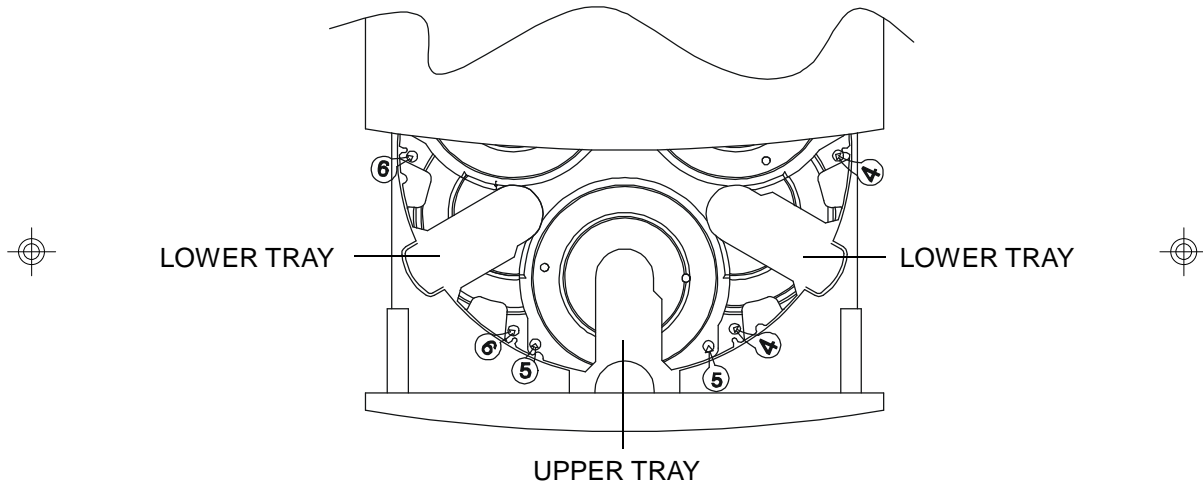

- 3.) Place 1, 2, or 3 CDs in the 3 pockets on the front of the tray.

IMPORTANT: Make sure that the discs are properly positioned in the center of each pocket. If the discs are not centered properly they may not be recognized by the player, or they could jam in the mechanism.

Disc pockets 1, 3, and 5 are in the upper tray. Disc pockets 2, 4, and 6 are in the lower tray. The pockets in the lower tray are partially covered by the pockets in the upper tray. To load CDs in the lower tray pick up the disc with your index finger in the center and your thumb on the outer edge, as shown in the following illustrations, and slide the disc into the desired pocket on the lower tray. Again, make sure that the disc is properly centered in the pocket, otherwise it may not be recognized by the player.

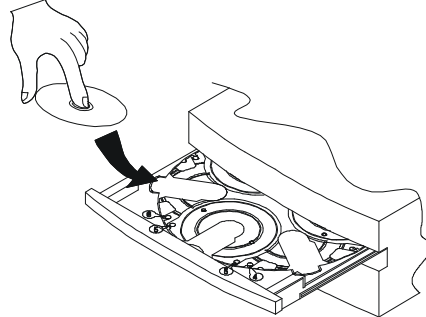
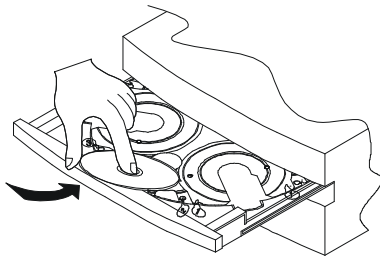

- 4.) Press the lower half (FRONT) of the OPEN/CLOSE button on the front panel, or the FRONT open button on the remote control, to close the CD drawer. After the drawer closes the tray will rotate so that the 3 front pockets will move to the rear. The player will begin to search for a disc. It will read the first disc that it finds and the display will show the total tracks and playing time of that disc. Also, the number of the disc in the play position will be flashing.

- 5.) If you wish to begin playback immediately press the PLAY/PAUSE **▶||** button on the front panel or the PLAY **▶** button the remote control. If you wish to load additional discs press the lower half (FRONT) of the OPEN/CLOSE button on the front panel, or the FRONT open button on the remote control, to open the CD drawer again. The drawer will open with the 3 remaining empty pockets facing you.

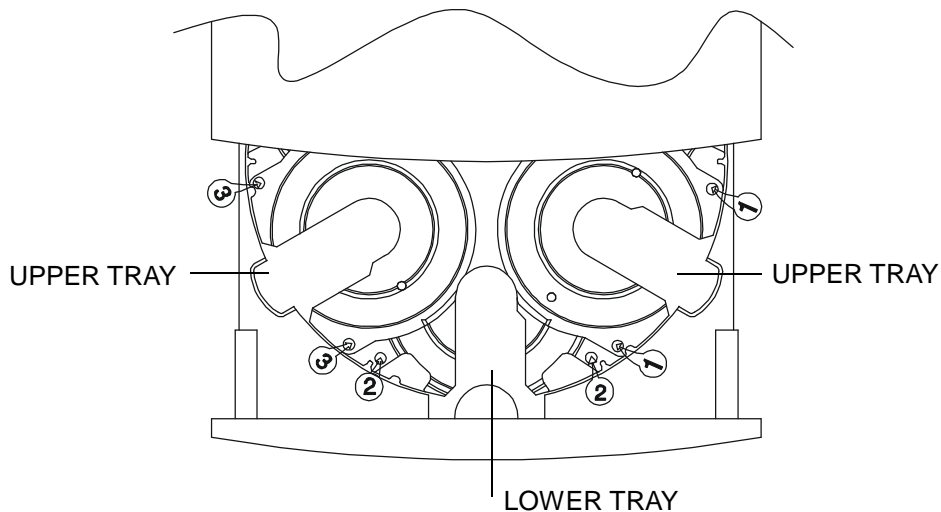

Place 1, 2, or 3 additional discs in the empty pockets.



- 6.) Press the lower half (FRONT) of the OPEN/CLOSE button on the front panel, or the FRONT open button on the remote control, to close the CD drawer. The player will read the disc that is in the play position and display the total tracks and playing time of that disc. One of the disc numbers will be flashing to indicate which disc is in the play position. For each disc on the tray the corresponding DIRECT ACCESS button on the front panel will light up.
- 7.) To begin playback of the disc in the play position press the PLAY/PAUSE ►|| button on the front panel or the PLAY ► button on the remote control. To begin playback of a different disc you can press the DISC SKIP button to move to the next disc, or press one of the 6 DIRECT ACCESS buttons to move directly to any disc in the player.
- 8.) When playback begins the half circle icon flashes above the number of the disc being played, and the DIRECT ACCESS button of the playing disc remains 'On'.
- 9.) Adjust the VOLUME, X-BASS controls as desired.
- 10.) Playback will continue until all tracks on all discs have been played. Then the player stops and the display shows the total tracks and playing time of the last disc that played. Press the lower half (FRONT) of the OPEN/CLOSE button on the front panel, or the FRONT open button on the remote control, to open the CD drawer. Remove the first 3 discs, close the drawer. Wait until the tray rotates, press the FRONT OPEN button again and remove the remaining 3 discs.

PAUSE CONTROL

To pause momentarily during playback press the PLAY/PAUSE ►|| button on the front panel or the PAUSE ||| button on the remote control. The sound stops, the Pause “|||” indicator appears in the display and the appropriate Direct Access button flashes. However the disc continues to spin. To cancel pause and resume normal playback press the PLAY/PAUSE ►|| button on the front panel or the PLAY ► button on the remote control once more.



TRACK SKIP AND MUSIC SEARCH

During CD playback press the ►► (Forward) or ◀◀ (Reverse) buttons to skip to higher or lower numbered tracks. Each time the buttons are pressed the player will skip one track and playback will begin on the new track.

During CD playback depress and hold the ►► (Forward) or ◀◀ (Reverse) buttons to search through a track at high speed to locate or bypass a specific portion of a song. The player will search rapidly forward or backward as long as the buttons are depressed. Normal playback will resume when the buttons are released.

STOP ■ BUTTON

After all discs have played the player stops automatically and the display shows the total tracks and playing time of the last that played. Also the disc number of the disc in the play position continues to flash. To stop playback at any time press the STOP ■ button. The display will show the total tracks and playing time of the disc in the play position.

DISC SCAN BUTTON

Press this button during playback to move immediately to the next higher numbered disc in the drawer. Playback begins automatically on the next disc. If the button is pressed twice the player will move ahead two discs, and so on.

DIRECT DISC ACCESS BUTTONS

Press the appropriate button to begin immediate playback on any disc in the drawer. The button of the selected disc remains 'On' and all of the other buttons go 'Off'.

REPEAT PLAYBACK

You can repeat a single track, one disc, or all discs continuously with the repeat function. Press the REPEAT button one, two, or three times to select **1 Track**, **1 Disc**, or **All Discs** Repeat. The appropriate **REPEAT** indicator appears in the display.

To cancel Repeat playback continue pressing the REPEAT button until the REPEAT indicator disappears.

Repeat Playback can be selected while a disc is playing, or in the Stop mode.



RANDOM PLAYBACK (Remote Control Only)

Press the RANDOM button on the remote control to play the tracks on each disc in random order. The RANDOM indicator appears in the display and random playback will begin with the disc that is in the play position. When all tracks on that disc have been played in random order the changer moves to the next disc and plays all the tracks on that disc in random order. When all tracks on all discs have played, the player stops and the display shows the total tracks and playing time of the last disc.

Random playback can be selected while a disc is playing or while the player is in the stop mode.

To cancel random playback press the RANDOM button until the RANDOM indicator disappears.

INTRO SCAN PLAYBACK (Remote Control Only)

Press the INTRO button on the remote control only to begin Intro Scan playback. The INTRO indicator appears and the player will play the first 10 seconds of every track on each disc in the player, starting with the disc that is in the play position. You can begin Intro playback while a disc is playing or while the player is in the stop mode. After the first 10 seconds of each track have been played the player stops automatically.

To cancel Intro playback at any time press the INTRO button again. The INTRO indicator disappears and normal playback resumes.



PROGRAMMED PLAYBACK

The CD changer has a 32 track programmable memory that allows you to select up to 32 of your favorite tracks from among all the discs in the changer for playback in any desired order.

Note:

You cannot program the changer while a disc is playing. If a disc is playing press the STOP ■ button first before beginning the programming steps below.

- 1.) Load up to 6 discs in the changer.
- 2.) Press the PROGRAM button. The MEMORY indicator comes 'On' and the display appears as follows:

This indicates that disc 6 is in the play position.



- 3.) Press the DISC SCAN button or the appropriate DIRECT ACCESS button to select the disc number that contains the first track you wish to program.

Example: Disc 2. The disc number indicator changes but the tray does not turn.



- 4.) Press the ►► (Forward) or ◀◀ (Reverse) buttons to select the first track number to be programmed.

Example: Track 9.

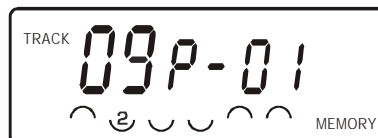



- 5.) When the desired Disc number and Track number appear on the display press the PROGRAM button to enter the info in memory.

The track number returns to "00" and the program number advances to "P - 02" indicating that you can select the second disc number and track number to be memorized.



- 6.) Repeat Steps 3, 4, and 5 to enter up to 32 tracks in the Program Memory.

- 7.) Press the PLAY/PAUSE ►|| button to begin programmed playback. The MEMORY indicator remains 'On' and playback will begin on the first track that you programmed. The display will show the disc number and track number of the track being played.



Note: If you press the Track Skip ◀◀/▶▶ buttons during programmed playback the player will skip to the next track in the programmed sequence, not the next track on the disc being played.

After each programmed track has been played the player stops but the MEMORY indicator remains 'On' and the program remains in the memory. If you press the PLAY/PAUSE ►|| button while the MEMORY indicator remains 'On' the programmed sequence will be played again. To cancel the program after the player has stopped press the STOP ■ button again. The MEMORY indicator goes 'Off'.

To cancel the program while the player is playing, press the STOP ■ button twice. The MEMORY indicator goes 'Off'.



CASSETTE OPERATION

PLAYING CASSETTE TAPES

- 1.) Press the POWER button to turn the system 'On'. The POWER ON indicator lights.
- 2.) Slide the FUNCTION selector to the 'TAPE' position.
- 3.) Press the STOP/EJECT key to open the cassette door.
- 4.) Insert a prerecorded cassette into the slots on the door with the exposed tape facing down and the full reel on the left side. Close cassette door.
- 5.) Press the PLAY key to begin playback.
- 6.) Adjust the VOLUME, and X-BASS controls as desired.
- 7.) When the tape ends the Automatic Stop System releases the PLAY key and shuts off the tape motor. Press the STOP/EJECT key to open the cassette door and remove your tape. To stop the tape before it ends press the STOP/EJECT key at any time.

F. FWD (Fast Forward) and REWIND CONTROLS

Press F. FWD key or REWIND key to advance or rewind the tape rapidly. When you reach the desired portion, or the end of the tape, press the PLAY key to resume normal playback, or press the STOP key to shut off the tape motor.

Note: *the Automatic Stop System does not function in the fast forward or rewind modes.*

PAUSE CONTROL

Press the PAUSE key to stop the tape temporarily. The tape movement stops but the tape motor continues to run. Press the PAUSE key again to cancel pause mode and resume normal playback.



MAKING A TAPE RECORDING

This cassette recorder features an Automatic Recording Volume Level Control System that prevents overloaded or distorted recordings. You can change the volume level as often as you like during the recording process. It will not have any effect on the volume level of the recording itself.

- 1.) Insert a good quality blank tape into the slots on the door with the exposed tape facing down and the full reel on the left side. Close the door.
- 2.) Select the source you wish to record – TUNER or CD , and operate that source as you normally would.
- 3.) Press the RECORD key on to begin recording.

STEREO HEADPHONE JACK

Connect an optional set of stereo headphones in PHONES jack on front panel for private listening without disturbing others. Before putting the headphones on your head reduce the volume to a low level. Then put the headphones on and gradually increase the volume to a comfortable listening level.



CARE AND MAINTENANCE

ABOUT CASSETTE TAPES

Whenever you record on a cassette any previously recorded material is erased as the new material is recorded. To prevent you from accidentally erasing material which you wish to save, blank cassettes are equipped with erase prevention tabs for each side of the tape. If the erase prevention tab for side A is removed, you cannot accidentally record on side A. The record key cannot be depressed if the erase prevention tab on the cassette has been removed.

To prevent accidental erasing on side A of a cassette use a small screw driver or similar tool to break off the erase prevention tab for side A. This prevents the record key from locking.

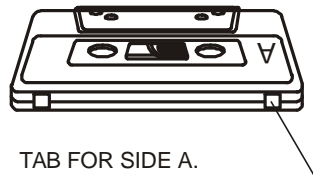

If later you do wish to record on side A of the cassette, cover the tab opening with a piece of cellophane tape. This will allow the record key to function again.

CASSETTE CARE

Two common causes of trouble experienced when using cassettes are:

- 1.) Tape jamming — Leading to uneven speed in playback, and
- 2.) Tape tangling — Where the tape wraps itself around vital parts of the mechanism.

To reduce the likelihood of these problems occurring, the following precautions should be observed:

- Check that there are no loose layers of tape visible through the cassette center window (see Fig. 1). Take up any loose layers, using a pencil or hexagonal barrelled ballpoint pen, before inserting the cassette into the machine (see Fig. 2).

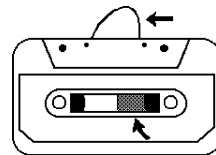

Fig.1



- If the cassette feels “tight” while performing operation shown (see Fig. 2), the tape may be jamming due to “ridges” formed in the winding of the tape. (visible through the center window). These may be removed, in most cases, by fast winding of the cassette from one end to the other and back again.

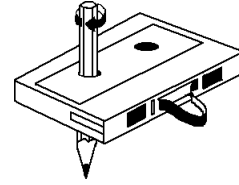

Fig.2

- Use only well-known brands of tape. Avoid use of C-120 cassettes.

Furthermore, do not expose cassettes to direct sunlight, dust or oil, and do not touch the tape surfaces.

HEAD CLEANING

The tape heads, pinch roller and capstan require periodic cleaning. This removes particles of the metal oxide coating that wear off the tape and accumulate on these parts and impair performance. Switch off the power, press the STOP/EJECT key, press the PLAY key to open the cassette door, and press the PLAY key. Clean the tape heads, pinch roller and capstan with a soft cloth or cotton pad dampened in isopropyl alcohol or special tape head cleaner.

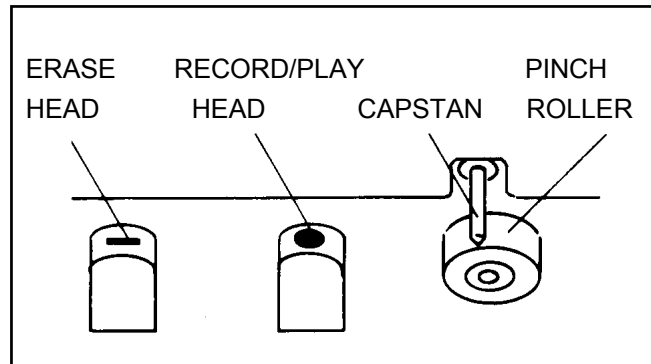

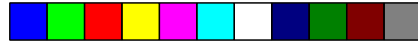

COMPACT DISC CARE

- To remove a disc from its storage case, press down on the center of the case and lift the disc out, holding it carefully by the edges.

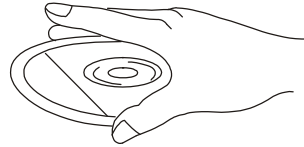
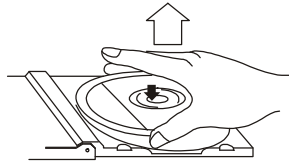

- Fingerprints and dust should be carefully wiped off the disc's recorded surface with a soft cloth. Unlike conventional records, compact discs have no grooves to collect dust and microscopic debris, so gently wiping with a soft cloth should remove most particles. Wipe in a straight line from the inside to the outside of the disc. Small dust particles and light stains will have absolutely no effect on reproduction quality.

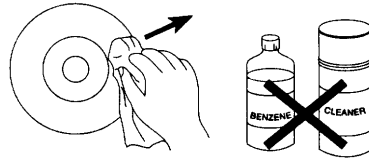
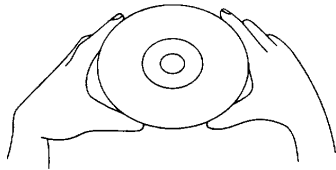

- Clean the disc periodically with a soft, lint-free, dry cloth. Never use detergents or abrasive cleaners to clean the disc. If necessary, use a CD cleaning kit.
- Never write on or affix labels to the surface of compact discs.



CARE OF THE CABINETS

- If the cabinets become dusty wipe them with a soft dry dust cloth. Do not use any wax or polish sprays on the cabinets.
- If the front panel becomes dirty or smudged with fingerprints it may be cleaned with a soft cloth slightly dampened with a mild soap and water solution. Never use abrasive cloths or polishes as these will mar the finish of your unit.

CAUTION !!

Never allow any water or other liquids to get inside the unit while cleaning.



TO FIND THE LOCATION AND PHONE NUMBER OF YOUR NEAREST SERVICE CENTER PERMITTED TO PERFORM WARRANTY...

CALL TOLL FREE: 1-800-695-0098

FOR ADDITIONAL SET-UP OR OPERATING ASSISTANCE
PLEASE CALL:
1-800-898-9020

FOR CUSTOMER SERVICE, PLEASE WRITE TO:
Emerson Radio Corp.
Consumer Affairs Dept.
1901 Diplomat Drive,
Farmers Branch, TX 75234.



LIMITED WARRANTY

Emerson Radio Corp. warrants manufacturing defects in original material, including original parts and workmanship, under normal use and conditions, for a period of ninety (90) days from the date of original purchase in the U.S. With your dated proof of purchase, we will provide repair service at no charge for labor and parts at an authorized Depot Repair Facility, or replace the product in our discretion. For repair or replacement, pack your unit in a padded box, enclose your check or money order payable to Emerson Radio Corp. in the amount of \$9.00 (not required by California residents) to cover shipping and handling costs, and enclose a copy of your proof of purchase. Send your unit to:

Emerson Radio Corp.
1901 Diplomat Drive.
Farmers Branch, TX 75234.

This warranty does not cover damage from negligence, misuse, abuse, accident, failure to follow operating instructions, commercial use, rental, repairs by an unauthorized facility, or products purchased, used, serviced or damaged outside of the United States.

THIS WARRANTY GIVES YOU SPECIFIC LEGAL RIGHTS, AND YOU MAY ALSO HAVE OTHER RIGHTS WHICH VARY FROM STATE TO STATE.

AU898M



EMERSON RADIO CORP.



EMERSON
PART NO. 16-2888
302-01

PRINTED IN CHINA

